



SILTEC®

C A B L E H Y G I E N E
C A B L E R O U T I N G S Y S T E M S

WIRE CABLE TRAYS

- for ONE cable

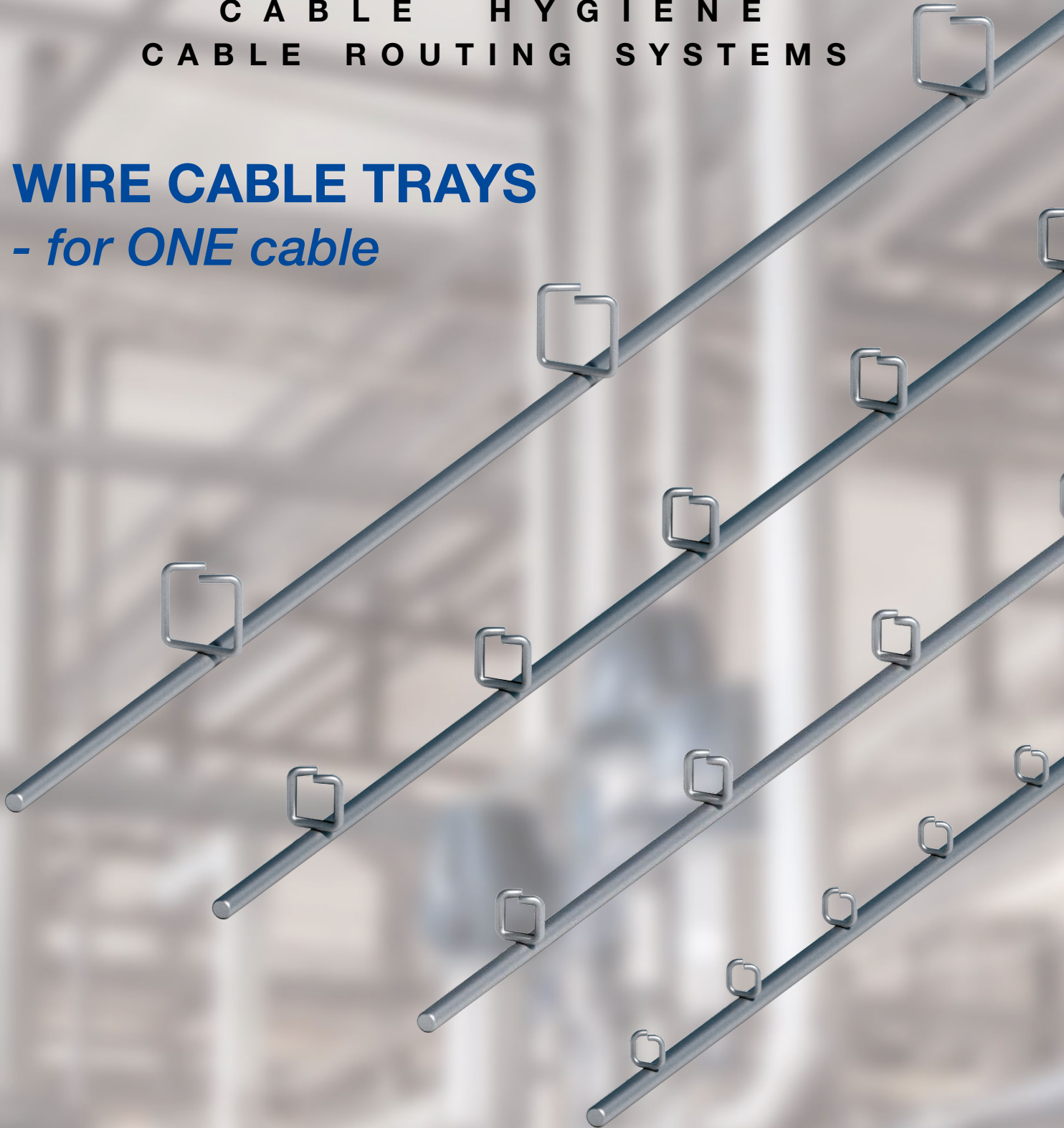

PRODUCT INFORMATION

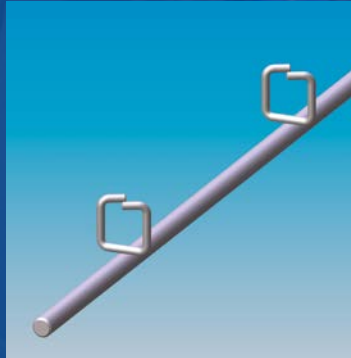

Table of Contents

Cable trays S320 - S337	Pgs	4 - 5
Dimensions and Assembly guidelines	Pgs	4 - 5
Product Overview	Pgs	6 - 7



SILTEC CABLE ROUTING SYSTEM

SILTEC cable routing system has been developed with optimal function in mind and with emphasis on simplicity and accessibility for the purposes of thorough cleaning and heat dissipation.

SILTEC cable routing system is made up of durable components of steel of highest quality, resistive to corrosion and with excellent chemical resistance.

SILTEC cable routing system is suitable for:

- The Food industry
- The Chemical industry
- Machine builders
- Office and computer environments
- Electrical installations in general

Cable trays are delivered in lengths of 3 meters. Width varies from 25 mm to 600 mm, and height from 25 mm to 125 mm.

Cable trays with custom measurements are made upon request.

All cable trays are made of round material which is gentle on cables, tubing, installers and maintenance personnel.

SILTEC cable trays are produced in

- Stainless steel (Aisi 316 and 304)
- Hot-dip galvanized material
- Electro-galvanized material

SILTEC cable routing system solves issues with the transport of energy in cables – simple, effective and environmentally correct.

SILTEC CABLE ROUTING SYSTEM

- Comes with the following wire cable tray types



Open standard cable trays



Locking cable trays



Open compact trays



Heavy duty cable trays



Cable trays f. one layer cable



Cable trays for one cable

In addition, we offer a large number of specialty trays and a comprehensive program of assembly parts, mounts and accessories.

Siltec Cable trays - for ONE cable

Fittings for installation with screws

S320		5 x 5 x 3000 mm - ø5 mm 316 St. Steel 570598 699320 3
S321		5 x 5 x 3000 mm - ø5 mm 316 St. Steel 570598 699321 0
S322		8 x 8 x 3000 mm - ø5 mm 316 St. Steel 570598 699322 7
S323		10 x 10 x 3000 mm - ø5 mm 316 St. Steel 570598 699323 4
S324		12 x 12 x 3000 mm - ø5 mm 316 St. Steel 570598 699324 1
S325		16 x 16 x 3000 mm - ø5 mm 316 St. Steel 570598 699325 8
S327		27 x 27 x 3000 mm - ø5 mm 316 St. Steel 570598 699327 2

S330
570598 699330 2
Polypropylene

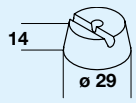

S330BD
570598 699330 2
Polypropylene
Detectable

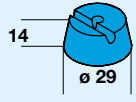

S334

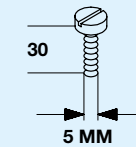

S331
570598 699331 9
Polypropylene

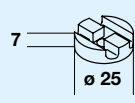

S331
570598 199633 9
Polypropylene
Detectable

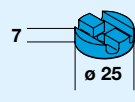

S90

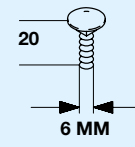

S91

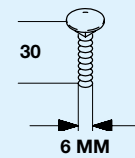

S 332
570598 699332 6

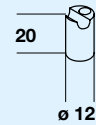

S334

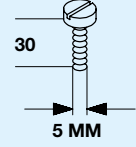

S333



Dimensions and Mounts

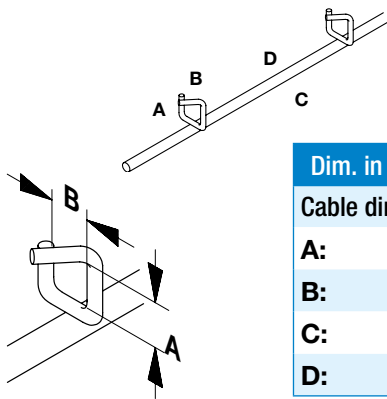

All dimensions in millimeters!

Dim. in mm.	S320	S321	S322	S323	S324	S325	S327
Cable dim.:	ø3 - 5	ø3 - 5	ø4 - 7	ø7 - 10	ø9 - 12	ø11 - 16	ø11 - 26
A:	5	5	8	10	12	16	27
B:	5	5	8	10	12	16	27
C:	3000	3000	3000	3000	3000	3000	3000
D:	50	100	100	100	100	200	200

S331
Variable

S324, S325 & S327
Max 1 cable tray

S330

5 MM

S331

Using 3 or 4 S331, S91
must be used

S332





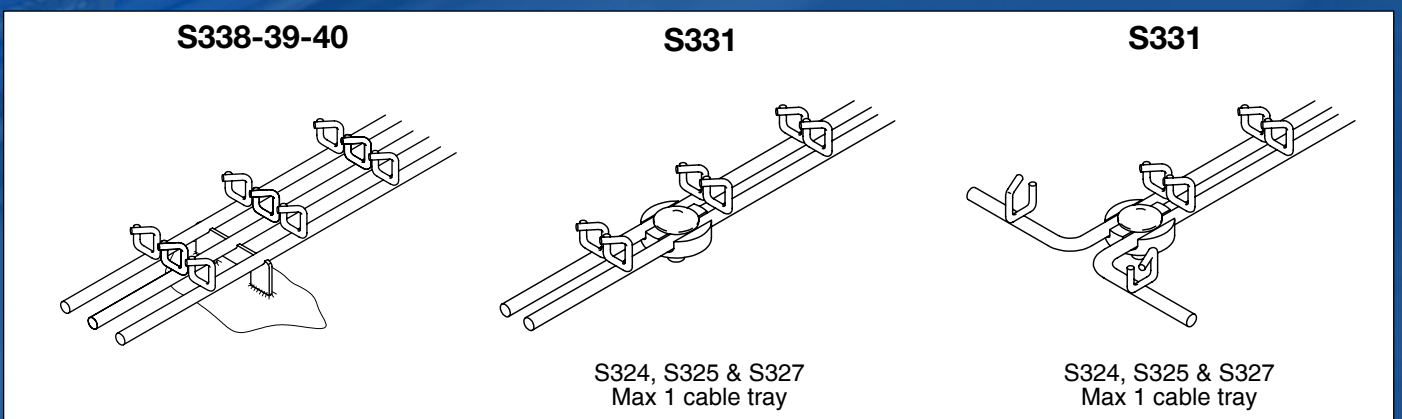
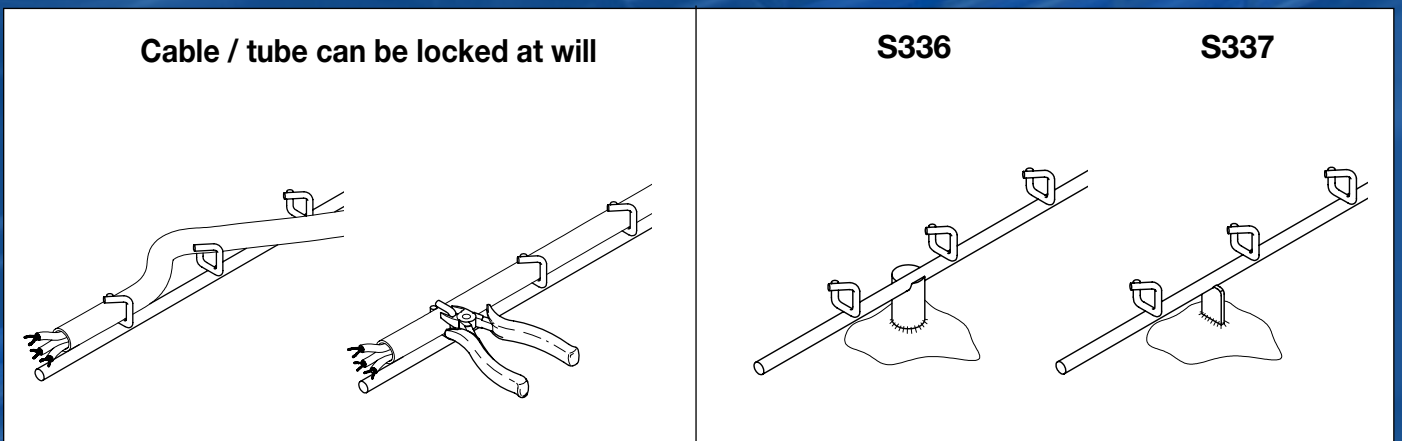
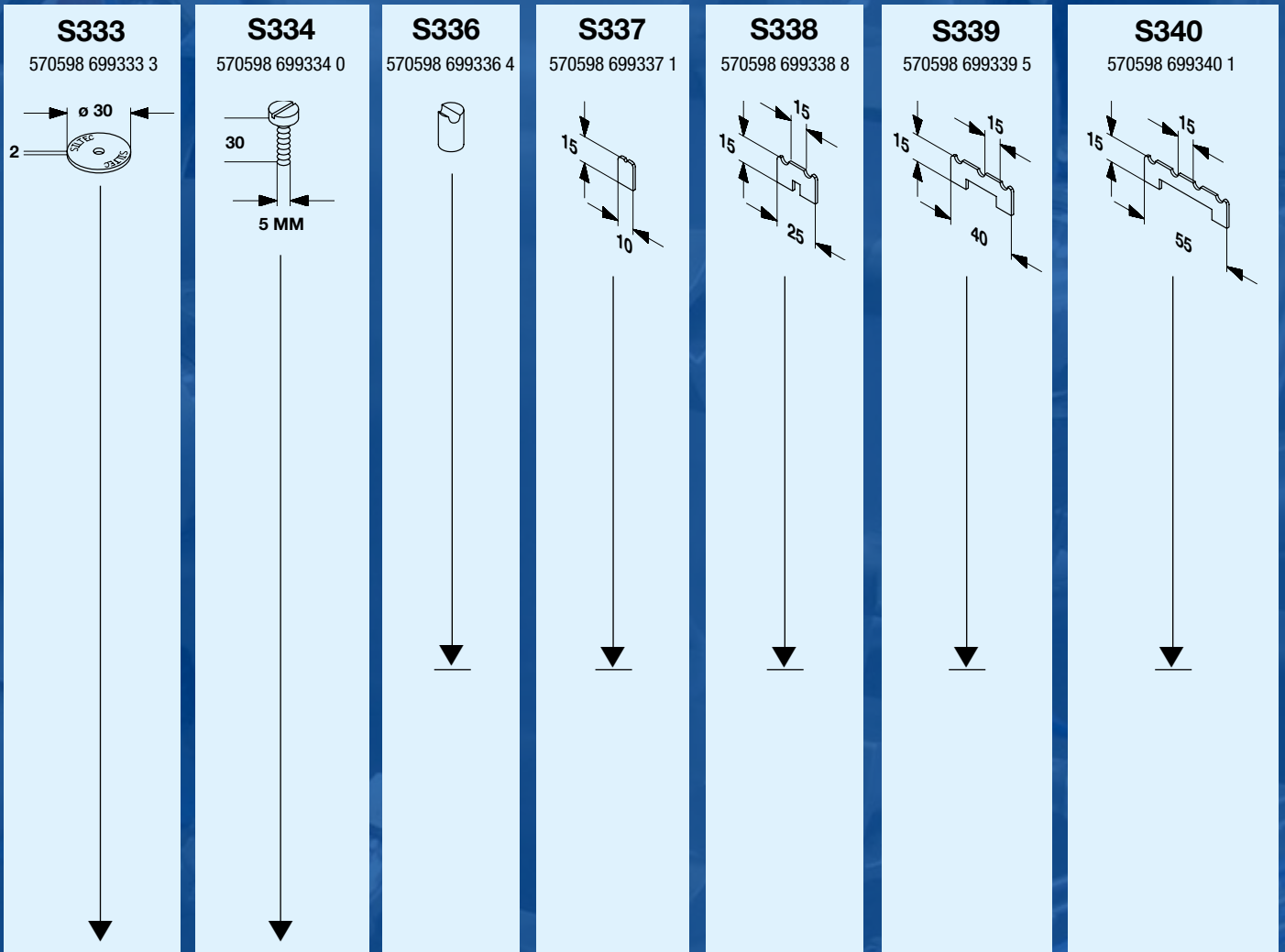







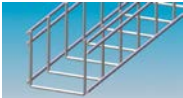

5 MM

Fittings for installation with weld-mount







SILTEC has a Cable Tray for Every Need

Standard - open trays

S25		25 x 25 x 3000 mm - ø4 mm 316 St. Steel 570598 620105 6 304 St. Steel 570598 720105 5 Hot dip galv. 570598 520105 7 El. pl. Zinc 570598 320105 9
S26		50 x 50 x 3000 mm - ø4 mm 316 St. Steel 570598 620106 3 304 St. Steel 570598 720106 2 Hot dip galv. 570598 520106 4 El. pl. Zinc 570598 320106 6
S27		75 x 75 x 3000 mm - ø5 mm 316 St. Steel 570598 620107 0 Hot dip galv. 570598 520107 1 El. pl. Zinc 570598 320107 3
S28		100 x 100 x 3000 mm - ø5 mm 316 St. Steel 570598 620108 7
S30M		35 x 40 x 3000 mm - ø4 mm 304 St. Steel 570598 720117 8 Hot dip galv. 570598 520117 0 El. pl. Zinc 570598 320117 2
S30		45 x 60 x 3000 mm - ø4 mm 316 St. Steel 570598 720118 6 304 St. Steel 570598 720118 5 Hot dip galv. 570598 520118 7 El. pl. Zinc 570598 320118 9
S30*		45 x 60 x 3000 mm - *ø5 mm 316 St. Steel 570598 620119 3 304 St. Steel 570598 720119 2 Hot dip galv. 570598 520119 4 El. pl. Zinc 570598 320119 6
S35		55 x 100 x 3000 mm - ø4 mm 304 St. Steel 570598 720120 8 Hot dip galv. 570598 520120 0 El. pl. Zinc 570598 320120 2
S35*		55 x 100 x 3000 mm - *ø5 mm 316 St. Steel 570598 640120 3 304 St. Steel 570598 740120 2 Hot dip galv. 570598 540120 4 El. pl. Zinc 570598 340120 6
S35W		55 x 150 x 3000 mm - ø5 mm 316 St. Steel 570598 620120 9 304 St. Steel 570598 720121 5 Hot dip galv. 570598 520121 7 El. pl. Zinc 570598 320121 9
S36		55 x 200 x 3000 mm - ø5 mm 316 St. Steel 570598 640121 0 304 St. Steel 570598 740121 9 Hot dip galv. 570598 540121 1 El. pl. Zinc 570598 340121 3
S37		55 x 300 x 3000 mm - ø5 mm 316 St. Steel 570598 640122 7 304 St. Steel 570598 740122 6 Hot dip galv. 570598 540122 8 El. pl. Zinc 570598 340122 0
S38		55 x 400 x 3000 mm - ø5 mm 316 St. Steel 570598 640123 4 304 St. Steel 570598 740123 3 Hot dip galv. 570598 540123 5 El. pl. Zinc 570598 340123 7
S39		55 x 500 x 3000 mm - ø5 mm 316 St. Steel 570598 640124 1 304 St. Steel 570598 740124 0 Hot dip galv. 570598 540124 2
S39W		55 x 600 x 3000 mm - ø5 mm 304 St. Steel 570598 740126 4 Hot dip galv. 570598 540126 6







Standard - open trays

S30M-X		50 x 57 x 3000 mm - ø4 mm 304 St. Steel 570598 786175 4
S30-X		70 x 68 x 3000 mm - ø4 mm 304 St. Steel 570598 786180 8
S35-X		70 x 114 x 3000 mm - ø4 mm 304 St. Steel 570598 786181 5
S36-X		70 x 207 x 3000 mm - ø5 mm 304 St. Steel 570598 786185 3

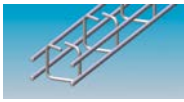
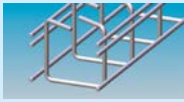
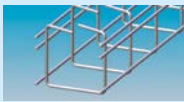
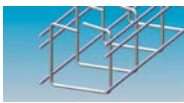
COMPACT Trays

S115		9 x 23 x 3000 mm - ø3 mm 304 St. Steel 570598 720115 4
S116		13 x 30 x 3000 mm - ø3 mm 304 St. Steel 570598 720116 1
S125		8 x 24x 2800 mm - ø3 mm 316 St. Steel 570598 610105 9
S126		30 x 50 x 3000 mm - ø4 mm 304 St. Steel 570598 790126 9
S127		30 x 75 x 3000 mm - ø4 mm 304 St. Steel 570598 790127 6
S128		30 x 100 x 3000 mm - ø4 mm 304 St. Steel 570598 790128 3
S129		30 x 125 x 3000 mm - ø5 mm 304 St. Steel 570598 790129 0
S130		30 x 150 x 3000 mm - ø5 mm 304 St. Steel 570598 790130 6
S131		30 x 250 x 3000 mm - ø5 mm 304 St. Steel 570598 790131 3
S132		30 x 350 x 3000 mm - ø5 mm 304 St. Steel 570598 790132 0
S133		30 x 450 x 3000 mm - ø5 mm 304 St. Steel 570598 790133 7











Tray with lock

S20		25 x 25 x 3000 mm - ø4 mm 316 St. Steel 570598 610100 4 Hot dip galv. 570598 510100 5 El. pl. Zinc 570598 310100 7
S20N		25 x 25 x 3000 mm - ø4 mm 304 St. Steel 570598 710100 3
S21		50 x 50 x 3000 mm - ø4 mm 316 St. Steel 570598 610101 1 Hot dip galv. 570598 510101 2 El. pl. Zinc 570598 310101 4
S21N		50 x 50 x 3000 mm - ø4 mm 304 St. Steel 570598 710101 0
S22		75 x 75 x 3000 mm - ø4 mm 316 St. Steel 570598 610102 8 Hot dip galv. 570598 510102 9 El. pl. Zinc 570598 310102 1
S22N		75 x 75 x 3000 mm - ø4 mm 304 St. Steel 570598 710102 7
S121		25 x 50 x 3000 mm - ø4 mm 304 St. Steel 570598 710121 8
S123		25 x 100 x 3000 mm - ø4 mm 304 St. Steel 570598 710123 2
K25		25 x 25 x 3000 mm - ø4 mm 304 St. Steel 570598 789104 1
K40		40 x 40 x 3000 mm - ø4 mm 304 St. Steel 570598 789102 7
K90		40 x 90 x 3000 mm - ø4 mm 304 St. Steel 570598 789106 5
K26		25 x 25 x 3000 mm - ø4 mm 304 St. Steel 570598 789105 8 With Welded-On Cover
K41		40 x 40 x 3000 mm - ø4 mm 304 St. Steel 570598 789103 4 With Welded-On Cover
K91		40 x 90 x 3000 mm - ø4 mm 304 St. Steel 570598 789107 2 With Welded-On Cover

Cable Trays for one layer of cables

S520		8 x 74 x 3000 mm 304 St. Steel 570598 720520 6
S521		12 x 74 x 3000 mm 304 St. Steel 570598 720521 3
S522		8 x 114 x 3000 mm 304 St. Steel 570598 720522 0
S523		12 x 114 x 3000 mm 304 St. Steel 570598 720523 7
S524		17 x 114 x 3000 mm 304 St. Steel 570598 720524 4

Heavy Duty Cable Trays

S235		100 x 100 x 3000 mm - ø5 mm 316 St. Steel 570598 688235 4 Hot dip galv. 570598 588235 5
S236		100 x 200 x 3000 mm - ø5 mm 316 St. Steel 570598 688236 1 Hot dip galv. 570598 588236 2
S237		100 x 300 x 3000 mm - ø5 mm 316 St. Steel 570598 688237 8 Hot dip galv. 570598 588237 9
S238		100 x 400 x 3000 mm - ø5 mm 316 St. Steel 570598 688238 5 Hot dip galv. 570598 588238 6
S239		100 x 500 x 3000 mm - ø5 mm 316 St. Steel 570598 688239 2 Hot dip galv. 570598 588239 3
S240		100 x 600 x 3000 mm - ø5 mm 316 St. Steel 570598 688240 8 Hot dip galv. 570598 588240 9
S428		100 x 100 x 3000 mm - ø5 304 St. Steel 570598 799428 5
S436		100 x 200 x 3000 mm - ø5 mm 304 St. Steel 570598 799436 0
S437		100 x 300 x 3000 mm - ø5 mm 304 St. Steel 570598 799437 7
S438		100 x 400 x 3000 mm - ø5 mm 304 St. Steel 570598 799438 4



CABLE HYGIENIC

FUNDER DALGÅRDSVEJ 2-6 . DK-8600 SILKEBORG

TLF: +45 86 85 18 00

www.siltec.dk / siltec@siltec.dk



SILTEC Distributeur Nederland:

CC Nederland B.V.
Facetlaan 4
2665 NR BLEISWIJK

Telefoon: 079 82 000 20
E-mail: info@ccned.nl
Internet: www.ccned.nl