

Emergency Stop Switches







X Series



High level of safety with Safe Break Action and Reverse Energy Structure.



• See website for details on approvals and standards.

| Series | Type | Features |
|---------------|--|---|
| ø16 XA Series |  Unibody | Small, unibody emergency stop switches. Only 19.5mm behind panel. |
| |  With Removable Contact | ø16 mm, 4-contact Emergency Stop Switch. Round form types also available. |
| ø22 XW Series |  Standard Bezel | Four different terminal styles. Can be used on FB series control stations. |
| |  Mechanical Indicator | Mechanical indicator on the operator body shows the contact status - green when NC contacts are closed - reducing maintenance work. |
| ø30 XN Series |  Plastic Bezel | ø60mm jumbo mushroom, and LED push-on models available. |
| |  Flush Bezel | Stylish design. Projects only 21mm from the panel. |
| |  Padlockable | Padlockable models can be locked using padlocks when latched. Prevents unauthorized resetting. |

Saves space

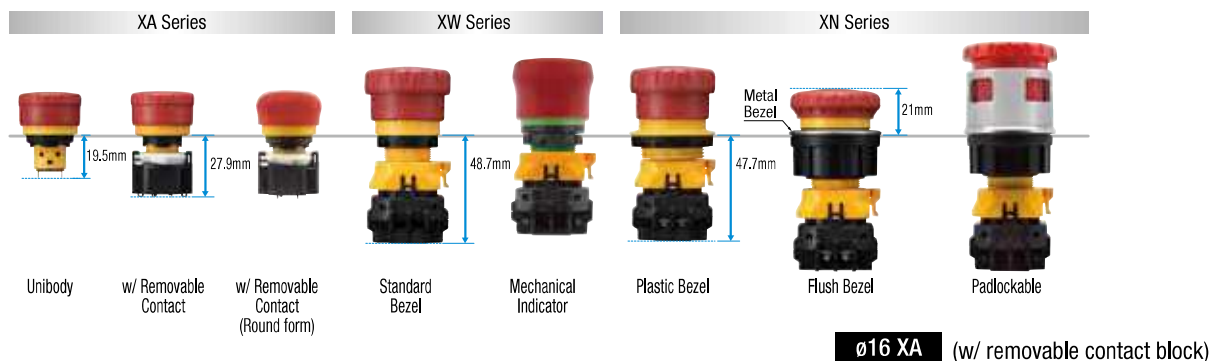

Prevents dust build-up



The round form button design is ideal for use on consumer equipment. The smooth and ridge-less button surface prevents dust build-up, and is also to clean

ø22 XW (Mechanical Indicator)

Normal/latched status can be checked from a distance with the mechanical indicator function.



The mechanical indicator on the operator body shows the normal/latched status (green: normal). Reduces maintenance work and improves operation efficiency.

ø30 XN (Padlockable)

Prevents unauthorized resetting using padlocks

The padlockable emergency stop switches are push-to-lock, turn/pull-to-reset emergency stop switches. Installing the padlock(s) on latched emergency stop switches prevents unauthorized resetting.

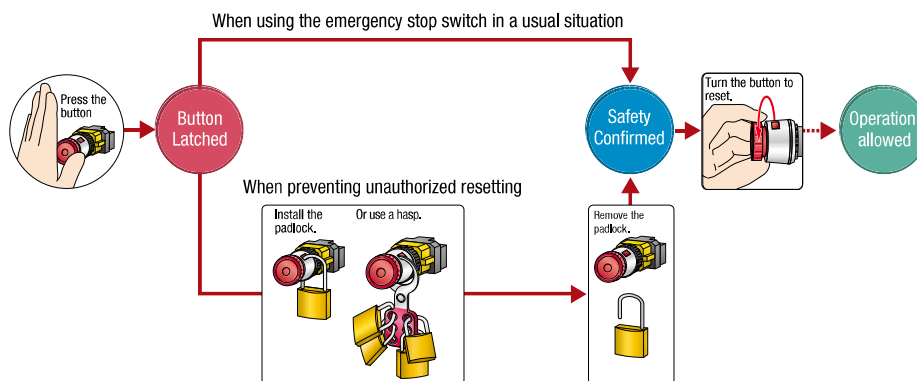

Multiple padlocks can be installed by using a hasp

Prevent resetting using padlocks

| | |
|---|--|
| <p>1 Worker A pushes the emergency stop switch and stops the machine.</p> | <p>2 Worker A locks the padlock to keep the emergency stop button in a pushed condition, and comes close to the machine to carry out maintenance work</p> |
| <p>3 Worker B does not notice worker A and tries to reset the emergency stop switch but cannot be reset because the padlock is locked.</p> | <p>4 Worker B cannot restart the machine.</p> <p>Safety</p> |

ø16 XA Series Emergency Stop Switches (Unibody)

Small, unibody emergency stop switches suitable for equipment with small mounting space. Requires only ø16mm × 19.5mm for installation.

- ø29mm and ø40mm mushroom operators
- Degree of protection IP65 and IP40 (IEC 60529)
- Dark red (Munsell 5R4/12) and bright red (Munsell 7.5R4.5/14) colors for operators of emergency stop switches.
- Silver with gold contacts.
- Push-to-lock, pull or turn-to-reset operator
- Safety lock mechanism (IEC 60947-5-5, 6.2)
- Direct opening action mechanism (IEC 60947-5-5, 5.2, IEC60947-5-1, Annex C)

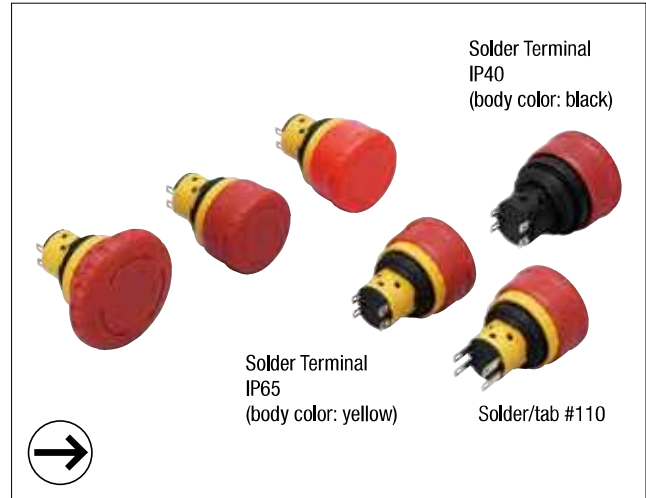

Standards and Specifications

Contact Ratings

| Rated Insulation Voltage (Ui) | | | 250V | | |
|-------------------------------|------------|------------------------|------|-------|------|
| Thermal Current (Ith) | | | 5A | | |
| Rated Operating Voltage (Ue) | | | 30V | 125V | 250V |
| Rated Operating Current | AC 50/60Hz | Resistive Load (AC-12) | — | 5A | 3A |
| | | Inductive Load (AC-15) | — | 3A | 1.5A |
| | DC | Resistive Load (DC-12) | 2A | 0.4A | 0.2A |
| | | Inductive Load (DC-13) | 1A | 0.22A | 0.1A |

- Minimum applicable load: 5V AC/DC, 1 mA (reference value) (May vary depending on the operating conditions and load.)
- The rated operating currents are measured at resistive/inductive loads as specified in IEC 60947-5-1.

Specifications



| | |
|--|--|
| Applicable Standards | IEC 60947-5-1, EN 60947-5-1 IEC 60947-5-5, EN 60947-5-5 JIS C8201-5-1, UL508, CSA C22.2 No.14 GB14048.5 |
| Operating Temperature | −25 to +60°C (no freezing) |
| Storage Temperature | −45 to +80°C (no freezing) |
| Operating Humidity | 45 to 85% RH (no condensation) |
| Operating Force | Push-to-lock: 10.5N Pull to reset: 10N Turn to reset: 0.16 N·m |
| Minimum Force Required for Direct Opening Action | 40N |
| Minimum Operator Stroke Required for Direct Opening Action | 4.0 mm |
| Maximum Operator Stroke | 4.5 mm |
| Contact Resistance | 50 mΩ maximum (initial value) |
| Insulation Resistance | 100 MΩ minimum (500V DC megger) |
| Overvoltage Category | II |
| Impulse Withstand Voltage | 2.5 kV |
| Pollution Degree | 3 |
| Operating Frequency | 900 operations/hour |
| Shock Resistance | Operating extremes: 150 m/s ² Damage limits: 1000 m/s ² |
| Vibration Resistance | Operating extremes: 10 to 500 Hz, amplitude 0.35mm, acceleration 50 m/s ² Damage limits: 10 to 500 Hz, amplitude 0.35 mm, acceleration 50 m/s ² |
| Durability | Mechanical: 250,000 Electrical: 100,000 250,000 (24V AC/DC, 100mA) |
| Degree of Protection | IP65, IP40 (IEC 60529) |
| Short-circuit Protection | 250V/10A fuse (Type aM IEC 60269-1/IEC 60269-2) |
| Conditional Short-circuit Current | 1000A |
| Terminal Style | Solder terminal, Solder/tab #110 terminal |
| Recommended Tightening Torque for Locking Ring | 0.88 N·m |
| Applicable Wire Size | 1.25 mm ² maximum (AWG16 maximum) |
| Terminal Soldering Condition | 310 to 350°C, within 3 seconds |
| Weight (approx.) | ø29mm mushroom: 14g ø40mm mushroom: 17g |

- APEM
- Switches & Pilot Lights
- Control Boxes
- Emergency Stop Switches
- Enabling Switches
- Safety Products
- Explosion Proof
- Terminal Blocks
- Relays & Sockets
- Circuit Protectors
- Power Supplies
- LED Illumination

- Controllers
- Operator Interfaces
- Sensors
- AUTO-ID
- X6
- XA
- XW
- XN
- SEMI

Pushlock Pull/Turn Reset (Solder Terminal)

XA Series

| Shape | Contact | Part No. | | ① Operator Color Code |
|---|---------|----------------------------|-----------------------------|--------------------------|
| | | IP40 (contact part: black) | IP65 (contact part: yellow) | |
|  ø29mm Mushroom | 1NC | XA1E-BV3U01K① | XA1E-BV3U01① | R: red RH: bright red |
| | 2NC | XA1E-BV3U02K① | XA1E-BV3U02① | |
|  ø40mm Mushroom | 1NC | XA1E-BV4U01K① | XA1E-BV4U01① | |
| | 2NC | XA1E-BV4U02K① | XA1E-BV4U02① | |

• Solder/tab #110 terminal is also available. Specify "T" before ① in the Ordering No.
XA1E-BV3U02KR → XA1E-BV3U02KTR

Dimensions

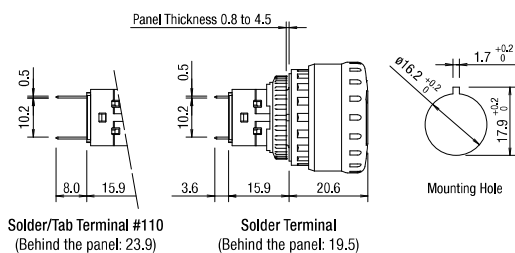

Terminal Arrangement (Bottom View)

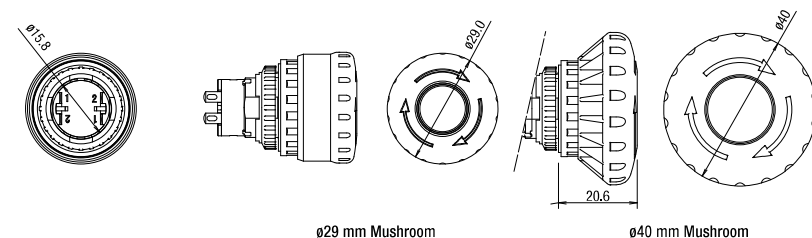
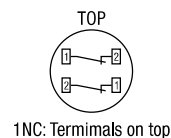

Mounting Hole Layout

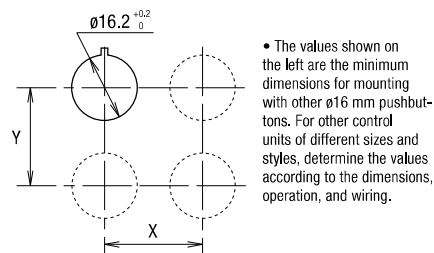

All dimensions in mm.

| | X | Y |
|----------------|---------------|---|
| ø29mm Mushroom | 40 mm minimum | |
| ø40mm Mushroom | 50 mm minimum | |

ø16 XA Series Emergency Stop Switches (w/Removable Contact Block)

Compact size - only 27.9 mm deep behind the panel. Reliable “Safe break action.”

- The depth behind the panel is only 27.9 mm for 1 to 4 contacts, both on illuminated and non-illuminated.
- IDEC's original “Safe break action” ensures that the contacts open when the contact block is detached from the operator.
- 1 to 4NC main contacts and 1NO monitor contact
- Push-to-lock, Pull or Turn-to-reset operator
- Direct opening action mechanism (IEC 60947-5-5, 5.2, IEC60947-5-1, Annex K)
- Safety lock mechanism (IEC 60947-5-5, 6.2)
- Degree of protection IP65 (IEC 60529)
- Silver with gold contacts.
- Two operator sizes: ø29 and ø40 mm
- Dark red (Munsell 5R4/12) or bright red (Munsell 7.5R4.5/14) colors are available for the operator of non-illuminated emergency stop switches.



Standards and Specifications

Contact Ratings

NC main contacts (black) /NO monitor contact (blue)

| Rated Insulation Voltage (Ui) | | 300V (illuminated part: 60V) | | | |
|-------------------------------|-------------|------------------------------|------|-------|------|
| Rated Thermal Current (Ith) | | 5A | | | |
| Rated Operating Voltage (Ue) | | 30V | 125V | 250V | |
| Main Contacts | AC 50/60 Hz | Resistive Load (AC-12) | – | 3A | 3A |
| | | Inductive Load (AC-15) | – | 1.5A | 1.5A |
| | DC | Resistive Load (DC-12) | 2A | 0.4A | 0.2A |
| | | Inductive Load (DC-13) | 1A | 0.22A | 0.1A |
| Monitor Contacts | AC 50/60 Hz | Resistive Load (AC-12) | – | 1.2A | 0.6A |
| | | Inductive Load (AC-14) | – | 0.6A | 0.3A |
| | DC | Resistive Load (DC-12) | 2A | 0.4A | 0.2A |
| | | Inductive Load (DC-13) | 1A | 0.22A | 0.1A |

- Minimum applicable load: 5V AC/DC, 1 mA (reference value)
(Operating area may vary according to the operating conditions and load types.)
- The rated operating currents are measured at resistive/inductive load types specified in IEC 60947-5-1.

Illumination Ratings

| Rated Voltage | Operating Voltage | Rated Current |
|---------------|-------------------|---------------|
| 24V AC/DC | 24V AC/DC ±10% | 11 mA |

Specifications



| | |
|--|---|
| Applicable Standards | IEC60947-5-1, EN60947-5-1, IEC60947-5-5, EN60947-5-5, JIS C8201-5-1, UL991, NFPA79, UL508, CSA C22.2 No.14, GB14048.5 |
| Operating Temperature | –25 to +60°C (no freezing) Illuminated: –25 to +55°C (no freezing) |
| Storage Temperature | –45 to +80°C |
| Operating Humidity | 45 to 85% RH (no condensation) |
| Operating Force | Push to lock: 10.5N Pull to reset: 10N Turn to reset: 0.16 N·m |
| Minimum Force Required for Direct Opening Action | 60N |
| Minimum Operator Stroke Required for Direct Opening Action | 4.0 mm |
| Maximum Operator Stroke | 4.5 mm |
| Contact Resistance | 50 mΩ maximum (initial value) |
| Insulation Resistance | 100 MΩ minimum (500V DC megger) |
| Oversoltage Category | II |
| Impulse Withstand Voltage | 2.5 kV |
| Pollution Degree | 3 (inside LED unit: 2) |
| Operation Frequency | 900 operations/hour |
| Shock Resistance | Operating extremes: 150 m/s ² Damage limits: 1000 m/s ² |
| Vibration Resistance | Operating extremes: 10 to 500 Hz, amplitude 0.35 mm acceleration 50 m/s ² Damage limits: 10 to 500 Hz, amplitude 0.35 mm acceleration 50 m/s ² |
| Mechanical Life | 250,000 operations minimum |
| Electrical Life | 100,000 operations min 250,000 operations min (24V AC/DC, 100 mA) |
| Degree of Protection | IP65 (IEC60529) |
| Short-circuit Protection | 250V/10A fuse (Type aM, IEC60269-1/IEC60269-2) |
| Conditional Short-circuit Current | 1000A |
| Terminal Style | Solder terminal, PC board terminal |
| Recommended Tightening Torque for Locking Ring | 0.88 N·m |
| Connectable Wire | 1.25 mm ² maximum (AWG16 maximum) |
| Soldering Conditions | 310 to 350°C, 3 seconds maximum |
| Weight | ø29 mm: 23g, ø40 mm: 28g |

For more information, visit <http://eu.idec.com>

APEM
Switches & Pilot Lights
Control Boxes
Emergency Stop Switches
Enabling Switches
Safety Products
Explosion Proof
Terminal Blocks
Relays & Sockets
Circuit Protectors
Power Supplies
LED Illumination
Controllers
Operator Interfaces
Sensors
AUTO-ID
X6
XA
XW
XN
SEMI



Pushlock Pull/Turn Reset (Solder Terminal/PC Board Terminal)

Non-illuminated

| Shape | NC Main Contact | NO Monitor Contact | Part No. | | Operator Color Code |
|---|-----------------|--------------------|-----------------|-------------------|-------------------------------|
| | | | Solder Terminal | PC Board Terminal | |
|  ø29mm Mushroom | 1NC | — | XA1E-BV301① | XA1E-BV301V① | R: Dark red RH: Bright red |
| | 2NC | — | XA1E-BV302① | XA1E-BV302V① | |
| | 3NC | — | XA1E-BV303① | XA1E-BV303V① | |
| | 4NC | — | XA1E-BV304① | XA1E-BV304V① | |
| | 1NC | 1NO | XA1E-BV311① | XA1E-BV311V① | |
| | 2NC | 1NO | XA1E-BV312① | XA1E-BV312V① | |
| | 3NC | 1NO | XA1E-BV313① | XA1E-BV313V① | |
|  ø40mm Mushroom | 1NC | — | XA1E-BV401① | XA1E-BV401V① | |
| | 2NC | — | XA1E-BV402① | XA1E-BV402V① | |
| | 3NC | — | XA1E-BV403① | XA1E-BV403V① | |
| | 4NC | — | XA1E-BV404① | XA1E-BV404V① | |
| | 1NC | 1NO | XA1E-BV411① | XA1E-BV411V① | |
| | 2NC | 1NO | XA1E-BV412① | XA1E-BV412V① | |
| | 3NC | 1NO | XA1E-BV413① | XA1E-BV413V① | |

- Specify a color code in place of ① in the Part No.
- Pushlock pull/turn reset switches are locked when pressed, and reset when pulled or turned clockwise.
- Terminal cover (XA9Z-VL2) is ordered separately.
- For EMO Switches, see **D-052**.

Illuminated

| Shape | NC Main Contact | NO Monitor Contact | Part No. | | Operator Color |
|---|-----------------|--------------------|-----------------|-------------------|----------------|
| | | | Solder Terminal | PC Board Terminal | |
|  ø29mm Mushroom | 1NC | — | XA1E-LV301Q4R | XA1E-LV301Q4VR | Dark red only |
| | 2NC | — | XA1E-LV302Q4R | XA1E-LV302Q4VR | |
| | 3NC | — | XA1E-LV303Q4R | XA1E-LV303Q4VR | |
| | 4NC | — | XA1E-LV304Q4R | XA1E-LV304Q4VR | |
| | 1NC | 1NO | XA1E-LV311Q4R | XA1E-LV311Q4VR | |
| | 2NC | 1NO | XA1E-LV312Q4R | XA1E-LV312Q4VR | |
| | 3NC | 1NO | XA1E-LV313Q4R | XA1E-LV313Q4VR | |
|  ø40mm Mushroom | 1NC | — | XA1E-LV401Q4R | XA1E-LV401Q4VR | |
| | 2NC | — | XA1E-LV402Q4R | XA1E-LV402Q4VR | |
| | 3NC | — | XA1E-LV403Q4R | XA1E-LV403Q4VR | |
| | 4NC | — | XA1E-LV404Q4R | XA1E-LV404Q4VR | |
| | 1NC | 1NO | XA1E-LV411Q4R | XA1E-LV411Q4VR | |
| | 2NC | 1NO | XA1E-LV412Q4R | XA1E-LV412Q4VR | |
| | 3NC | 1NO | XA1E-LV413Q4R | XA1E-LV413Q4VR | |

- Pushlock pull/turn reset switches are locked when pressed, and reset when pulled or turned clockwise.
- Terminal cover (XA9Z-VL2) is ordered separately.



ø16 XA Series Emergency Stop Switches (w/Removable Contact Block)

Dimensions

Non-illuminated

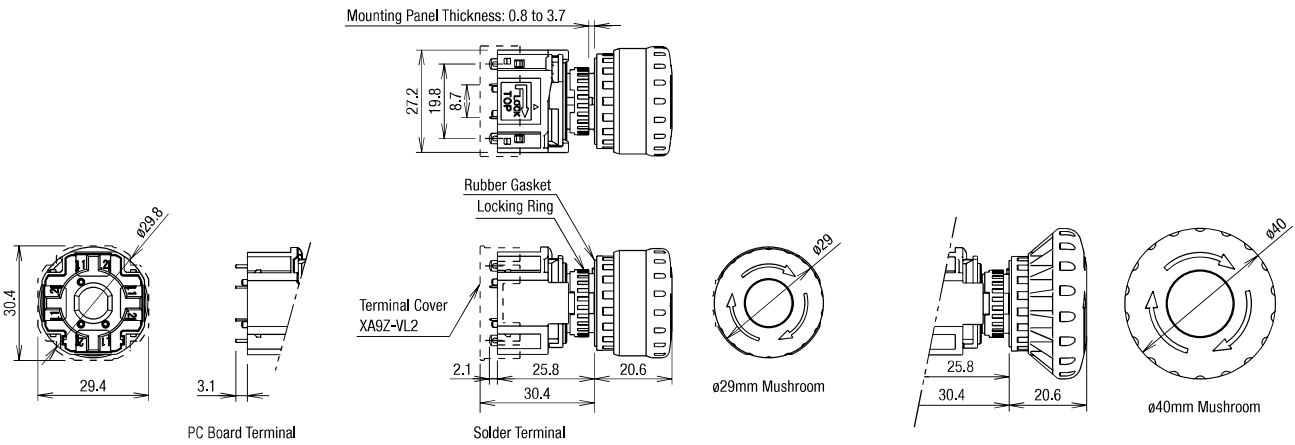

Illuminated

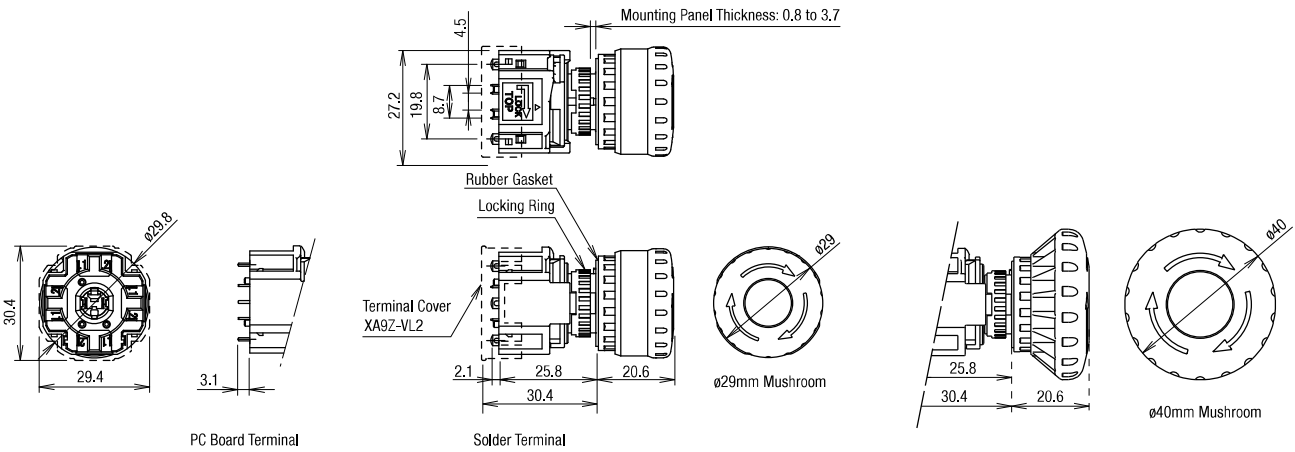

PC Board Layout (Bottom View)

Non-Illuminated

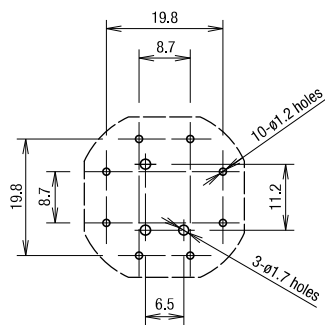

Illuminated

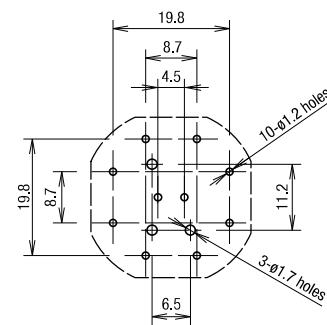

Panel Cut-out

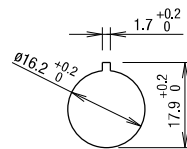

All dimensions in mm.

Mounting Hole Layout

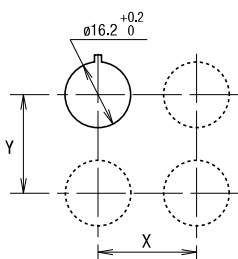

| | X | Y |
|----------------|---------------|---|
| ø29mm Mushroom | 40 mm minimum | |
| ø40mm Mushroom | 50 mm minimum | |

• The values shown above are the minimum dimensions for mounting with other ø16 mm pushbuttons. For other control units of different sizes and styles, determine the values according to the dimensions, operation, and wiring convenience.

LED Unit Internal Circuit

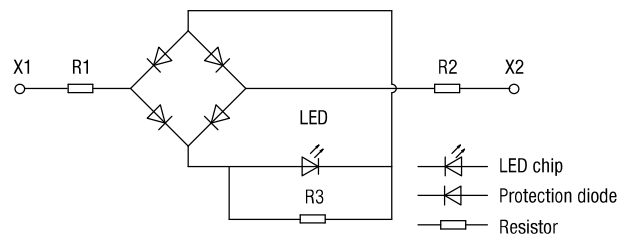

Terminal Arrangement (Bottom View)

Non-illuminated

NC main contacts (black) only

NC main contacts (black): Terminals 1-2

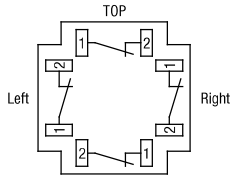

1NC: Terminals on right
 2NC: Terminals on right and left
 3NC: Terminals on right, left, and top

With NO monitor contacts (blue)

NC main contacts (black): Terminals 1-2

NO monitor contacts (blue): Terminals 3-4

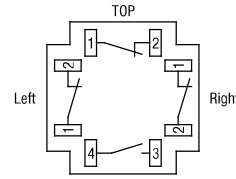

1NC: Terminals on top
 2NC: Terminals on right and left

Illuminated

NC main contacts only (black)

NC main contacts (black): Terminals 1-2

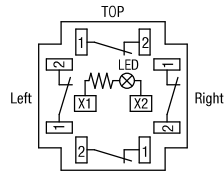

1NC: Terminals on right
 2NC: Terminals on right and left
 3NC: Terminals on right, left, and top

With NO monitor contacts (blue)

NC main contacts (black): Terminals 1-2

NO monitor contacts (blue): Terminals 3-4

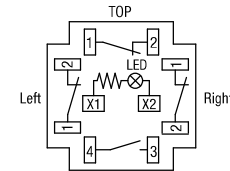

1NC: Terminals on top
 2NC: Terminals on right and left

- APEM
- Switches & Pilot Lights
- Control Boxes
- Emergency Stop Switches
- Enabling Switches
- Safety Products
- Explosion Proof
- Terminal Blocks
- Relays & Sockets
- Circuit Protectors
- Power Supplies
- LED Illumination
- Controllers
- Operator Interfaces
- Sensors
- AUTO-ID

X6

XA

XW

XN

SEMI



ø16 XA Series Emergency Stop Switches Round Form (w/Removable Contact Blocks)

Smooth Round Form Buttons

- IDEC's unique Reverse Energy Structure
- Depth behind the panel: 27.9mm
- Arrow marked and unmarked buttons.
- The smooth button is ideal for applications that require utmost cleanliness. Prevents dust built-up, and is also easy to clean.
- Two reset operations - pushlock pull or turn reset.
- Silver with gold contacts.
- Direct opening action (IEC60947-5-5:5.2, IEC60947-5-1, Annex K)
- Safety lock mechanism (IEC60947-5-5:6.2)
- Degree of protection IP65 (IEC60529)

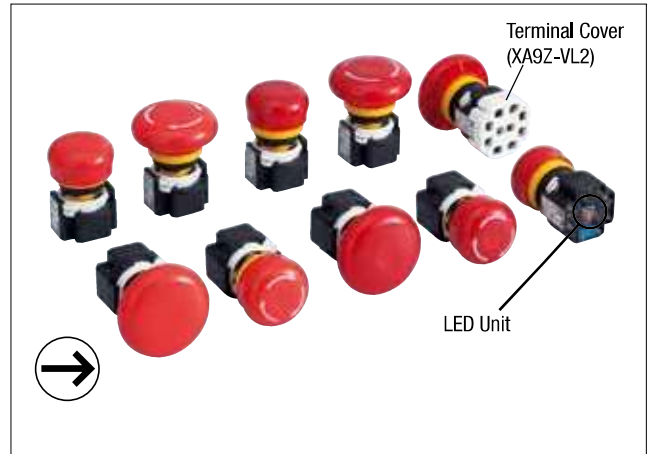

Standards and Specifications

Contact Ratings

NC main contacts (black) /NO monitor contact (blue)

| Rated Insulation Voltage (Ui) | | 300V (illuminated part: 60V) | | | | |
|-------------------------------|---------------|------------------------------|------------------------|------|-------|------|
| Rated Thermal Current (Ith) | | 5A | | | | |
| Rated Operating Voltage (Ue) | | 30V | 125V | 250V | | |
| Rated Operating Current | Main Contacts | AC 50/60 Hz | Resistive Load (AC-12) | – | 3A | 3A |
| | | | Inductive Load (AC-15) | – | 1.5A | 1.5A |
| | DC | | Resistive Load (DC-12) | 2A | 0.4A | 0.2A |
| | | | Inductive Load (DC-13) | 1A | 0.22A | 0.1A |
| Monitor Contacts | AC 50/60 Hz | | Resistive Load (AC-12) | – | 1.2A | 0.6A |
| | | | Inductive Load (AC-14) | – | 0.6A | 0.3A |
| | DC | | Resistive Load (DC-12) | 2A | 0.4A | 0.2A |
| | | | Inductive Load (DC-13) | 1A | 0.22A | 0.1A |

- Minimum applicable load: 5V AC/DC, 1 mA (reference value)
(Operating area may vary according to the operating conditions and load types.)
- The rated operating currents are measured at resistive/inductive load types specified in IEC 60947-5-1.

Illumination Ratings



| Rated Voltage | Operating Voltage | Rated Current |
|---------------|-------------------|---------------|
| 24V AC/DC | 24V AC/DC ±10% | 11 mA |

Specifications

| | |
|--|---|
| Applicable Standards | IEC60947-5-1, EN60947-5-1 IEC60947-5-5, EN60947-5-5, JIS C8201-5-1, UL991, NFPA79, UL508, CSA C22.2 No.14, GB14048.5 |
| Operating Temperature | –25 to +60°C (no freezing) Illuminated: –25 to +55°C (no freezing) |
| Storage Temperature | –45 to +80°C |
| Operating Humidity | 45 to 85% RH (no condensation) |
| Operating Force | Push to lock: 10.5N Pull to reset: 10N Turn to reset: 0.16 N·m |
| Minimum Force Required for Direct Opening Action | 60N |
| Minimum Operator Stroke Required for Direct Opening Action | 4.0 mm |
| Maximum Operator Stroke | 4.5 mm |
| Contact Resistance | 50 mΩ maximum (initial value) |
| Insulation Resistance | 100 MΩ minimum (500V DC megger) |
| Overvoltage Category | II |
| Impulse Withstand Voltage | 2.5 kV |
| Pollution Degree | 3 (inside LED unit: 2) |
| Operation Frequency | 900 operations/hour |
| Shock Resistance | Operating extremes: 150 m/s ² Damage limits: 1000 m/s ² |
| Vibration Resistance | Operating extremes: 10 to 500 Hz, amplitude 0.35 mm, acceleration 50 m/s ² Damage limits: 10 to 500 Hz, amplitude 0.35 mm, acceleration 50 m/s ² |
| Mechanical Life | 250,000 operations minimum |
| Electrical Life | 100,000 operations min 250,000 operations min (24V AC/DC, 100 mA) |
| Degree of Protection | IP65 (IEC60529) |
| Short-circuit Protection | 250V/10A fuse (Type aM, IEC60269-1/IEC60269-2) |
| Conditional Short-circuit Current | 1000A |
| Terminal Style | Solder terminal, PC board terminal |
| Recommended Tightening Torque for Locking Ring | 0.88 N·m |
| Connectable Wire | 1.25 mm ² maximum (AWG16 maximum) |
| Soldering Conditions | 310 to 350°C, 3 seconds maximum |
| Weight | ø30 mm: 23g, ø40 mm: 28g |

Pushlock Pull/Turn Reset (Solder Terminal)

Non-illuminated

| Shape | NC Main Contact | NO Monitor Contact | Part No. (Ordering Part No.) | |
|---|-----------------|--------------------|------------------------------|---------------|
| | | | Unmarked | Arrow Marked |
| ø30 Mushroom  | 3NC | – | XA1E-BV3T03RH | XA1E-BV3T03RM |
| | 4NC | – | XA1E-BV3T04RH | XA1E-BV3T04RM |
| | 1NC | 1NO | XA1E-BV3T11RH | XA1E-BV3T11RM |
| | 2NC | 1NO | XA1E-BV3T12RH | XA1E-BV3T12RM |
| | 3NC | 1NO | XA1E-BV3T13RH | XA1E-BV3T13RM |
| ø40 Mushroom  | 3NC | – | XA1E-BV4T03RH | XA1E-BV4T03RM |
| | 4NC | – | XA1E-BV4T04RH | XA1E-BV4T04RM |
| | 1NC | 1NO | XA1E-BV4T11RH | XA1E-BV4T11RM |
| | 2NC | 1NO | XA1E-BV4T12RH | XA1E-BV4T12RM |
| | 3NC | 1NO | XA1E-BV4T13RH | XA1E-BV4T13RM |

- Pushlock pull/turn reset switches are locked when pressed, and reset when pulled or turned clockwise.
- 1NC and 2NC contacts also available.
- Terminal cover (XA9Z-VL2) is ordered separately.
- For PC board terminals, add "V" in front of "R" in the part number.
Example: XA1E-BV3T03RH => XA1E-BV3T03VRH

Illuminated

| Shape | NC Main Contact | NO Monitor Contact | Part No. (Ordering Part No.) | |
|---|-----------------|--------------------|------------------------------|-----------------|
| | | | Unmarked | Arrow Marked |
| ø30 Mushroom  | 1NC | – | XA1E-LV3T01Q4R | XA1E-LV3T01Q4RM |
| | 2NC | – | XA1E-LV3T02Q4R | XA1E-LV3T02Q4RM |
| | 3NC | – | XA1E-LV3T03Q4R | XA1E-LV3T03Q4RM |
| | 4NC | – | XA1E-LV3T04Q4R | XA1E-LV3T04Q4RM |
| | 1NC | 1NO | XA1E-LV3T11Q4R | XA1E-LV3T11Q4RM |
| | 2NC | 1NO | XA1E-LV3T12Q4R | XA1E-LV3T12Q4RM |
| | 3NC | 1NO | XA1E-LV3T13Q4R | XA1E-LV3T13Q4RM |
| ø40 Mushroom  | 1NC | – | XA1E-LV4T01Q4R | XA1E-LV4T01Q4RM |
| | 2NC | – | XA1E-LV4T02Q4R | XA1E-LV4T02Q4RM |
| | 3NC | – | XA1E-LV4T03Q4R | XA1E-LV4T03Q4RM |
| | 4NC | – | XA1E-LV4T04Q4R | XA1E-LV4T04Q4RM |
| | 1NC | 1NO | XA1E-LV4T11Q4R | XA1E-LV4T11Q4RM |
| | 2NC | 1NO | XA1E-LV4T12Q4R | XA1E-LV4T12Q4RM |
| | 3NC | 1NO | XA1E-LV4T13Q4R | XA1E-LV4T13Q4RM |

- Pushlock pull/turn reset switches are locked when pressed, and reset when pulled or turned clockwise.
- Terminal cover (XA9Z-VL2) is ordered separately.
- For PC board terminals, add "V" in front of "R" in the part number.
Example: XA1E-LV3T01Q4R => XA1E-LV3T01Q4VR

ø16 XA Series Emergency Stop Switches Round Form (w/Removable Contact Blocks)

Dimensions

Panel Cut-out

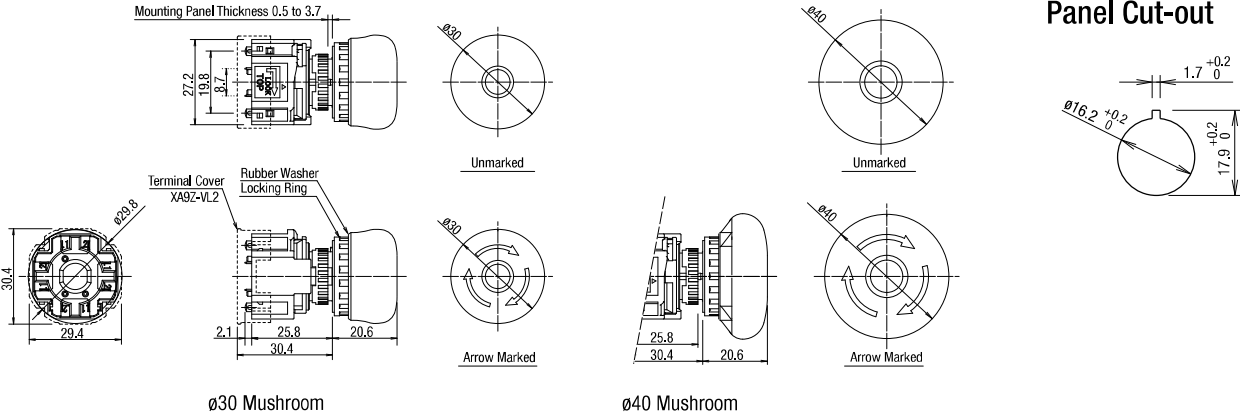

ø30 Mushroom

ø40 Mushroom

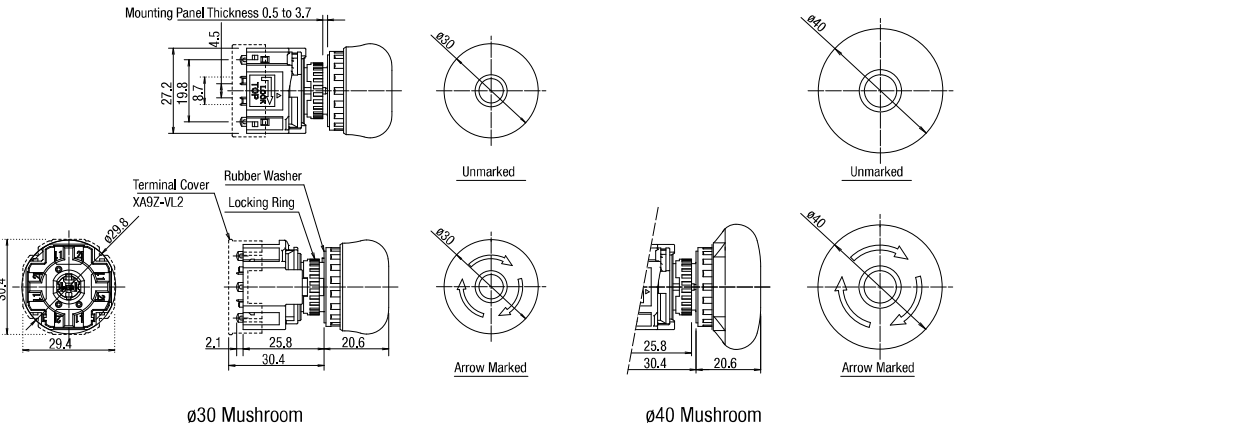

ø30 Mushroom

ø40 Mushroom

X6

XA

Terminal Arrangement (Bottom View)

XW

Non-illuminated

XN

NC main contacts (black) only
NC main contacts (black): Terminals 1-2

With NO monitor contacts (blue)
NC main contacts (black): Terminals 1-2
NO monitor contacts (blue): Terminals 3-4

Illuminated

NC main contacts only (black)
NC main contacts (black): Terminals 1-2

With NO monitor contacts (blue)
NC main contacts (black): Terminals 1-2
NO monitor contacts (blue): Terminals 3-4



1NC: Terminals on right
2NC: Terminals on right and left
3NC: Terminals on right, left, and top

1NC: Terminals on top
2NC: Terminals on right and left



1NC: Terminals on right
2NC: Terminals on right and left
3NC: Terminals on right, left, and top

1NC: Terminals on top
2NC: Terminals on right and left

Mounting Hole Layout

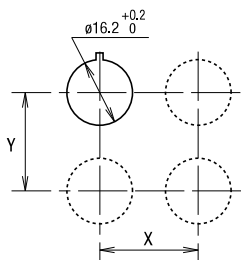

| | X | Y |
|----------------|---------------|---|
| ø29mm Mushroom | 40 mm minimum | |
| ø40mm Mushroom | 50 mm minimum | |

• The values shown above are the minimum dimensions for mounting with other ø16 mm pushbuttons. For other control units of different sizes and styles, determine the values according to the dimensions, operation, and wiring convenience.

LED Unit Internal Circuit

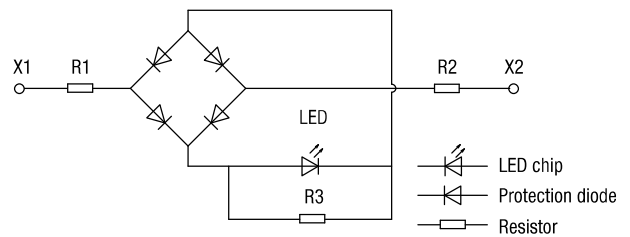

APEM

Switches & Pilot Lights

Control Boxes

Emergency Stop Switches

Enabling Switches

Safety Products

Explosion Proof

Terminal Blocks

Relays & Sockets

Circuit Protectors

Power Supplies

LED Illumination

Controllers

Operator Interfaces

Sensors

AUTO-ID

X6

XA

XW

XN

SEMI

Safety Precautions

- Turn off power to the XA series emergency stop switch before starting installation, removal, wiring, maintenance, and inspection of the relays. Failure to turn power off may cause electrical shock or fire hazard.
- Use the LED unit removal tool when replacing the LED unit to avoid burn on your hands.

- Use wires of the proper size to meet the voltage and current requirements, and solder the wires correctly. If soldering is incomplete, the wire may heat during operation, causing fire hazard.

Instructions

Removing the Contact Block

First unlock the operator button. While pushing up the white bayonet ring, using a small screwdriver (width: 2.5 to 3 mm) if necessary, turn the contact block counterclockwise and pull out. Do not exert excessive force when using a screwdriver, otherwise the bayonet ring may be damaged.

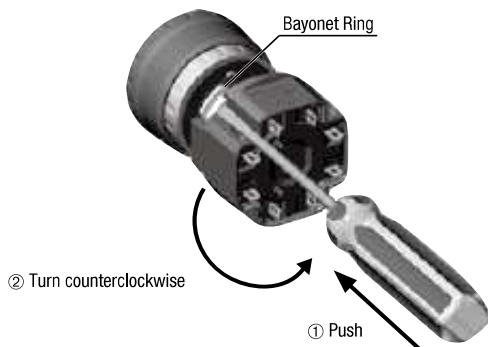

Notes for Removing the Contact Block

1. When the contact block is removed, the monitor contact (NO contact) is closed.
2. While removing the contact block, do not exert excessive force, otherwise the switch may be damaged.

Panel Mounting

Remove the locking ring from the operator and check that the rubber gasket is in place. Insert the operator from panel front into the panel hole. Face the side with the anti-rotation protrusion on the operator upward, and tighten the locking ring.

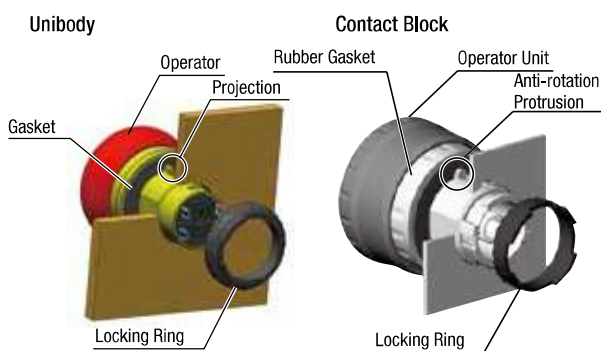

Notes for Panel Mounting

To mount the XA emergency stop switches onto a panel, tighten the locking ring to a tightening torque of 0.88 N·m maximum using ring wrench MT-001. Do not use pliers. Do not exert excessive force, otherwise the locking ring may be damaged.

Installing the Contact Block

First turn the bayonet ring to the unlocked position.

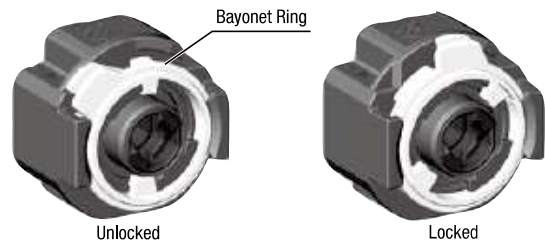

Align the small ▲ marking on the edge of the operator base with the TOP marking on the contact block. Press the contact block onto the operator and turn the contact block clockwise until the bayonet ring clicks.

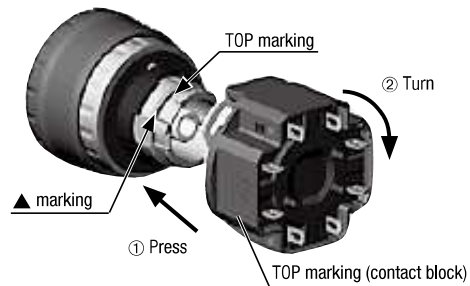

Notes for Installing the Contact Block

Check that the contact block is securely installed on the operator. When the emergency stop switch is properly assembled, the bayonet ring is in place as shown below.



Removing the LED Unit (Contact Block)

Pull out the LED unit while squeezing the latches on the LED unit using the LED unit removal tool (MT-101).

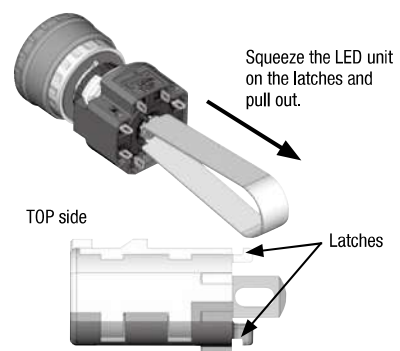

ø16 XA Series Emergency Stop Switches

Installing the LED Unit (with Removable Contact Block)

Align the top of the LED unit with the TOP marking on the contact block. Push the LED unit into the contact block.



Wiring

1. The applicable wire size is 1.25 mm² maximum.
2. Solder the terminal at a temperature of 310 to 350°C within 3 seconds using a soldering iron. Sn-Ag-Cu type is recommended when using lead-free solder. When soldering, do not touch the enabling switch with the soldering iron. Also ensure that no tensile force is applied to the terminal. Do not bend the terminal or apply excessive force to the terminal.
3. Use a non-corrosive rosin flux. To prevent the flux from entering the switch while soldering, face the terminals downward.
4. Because the terminal spacing is narrow, use protective tubes or heat shrinkable tubes to avoid burning of wire coating or short circuit.

Solder/Tab Terminal #110

1. Use #110 receptacles for 0.5mm-thick tabs.
2. Because the terminal spacing is narrow, use protective tubes or heat shrinkable tubes of 0.5mm minimum in thickness.
3. Do not apply force on the terminals in the direction other than vertical to the mounting panel, otherwise the terminals will be damaged.

PC Board Terminal

1. When mounting a contact block on a PC board, provide sufficient rotating space for the PC board when installing and removing the contact block.
2. When mounting an XA emergency stop switch on a PC board, make sure that the operator is securely installed.

About PC Board and Circuit Design

1. Use PC boards made of glass epoxy copper-clad laminated sheets of 1.6 mm in thickness, with double-sided through hole.
2. PC boards and circuits must withstand rated voltage and current, including the instantaneous current and voltage at switching.
3. The minimum applicable load is 5V AC/DC, 1 mA. This value may vary according to the operating environment and load.
4. Within the 2.8* mm areas shown in the figure below, terminals touch the PC board, resulting in possible short circuit on the printed circuit. When designing a PC board pattern, take this possibility into consideration.

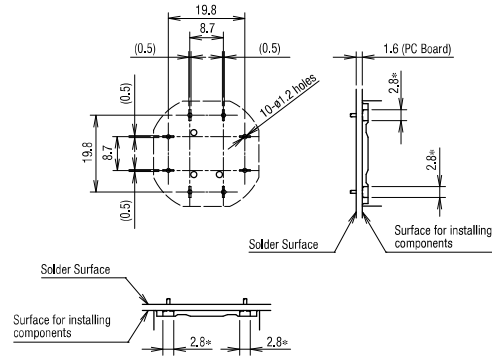

Installing Insulation Terminal Cover

To install the terminal cover (XA9Z-VL2), align the TOP marking on the terminal cover with TOP marking on the contact block, and press the terminal cover toward the contact block.

Note: For wiring, insert the wires into the holes in the terminal cover before soldering.

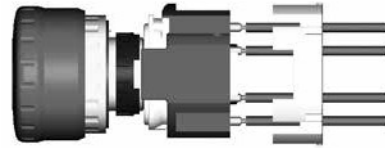

Contact Bounce

When the button is reset by pulling or turning, the NC main contacts will bounce. When pressing the button, the NO monitor contacts will bounce. When designing a control circuit, take the contact bounce time into consideration (reference value: 20 ms).

Nameplate

When anti-rotation is not required, remove the projection from the nameplate using pliers.

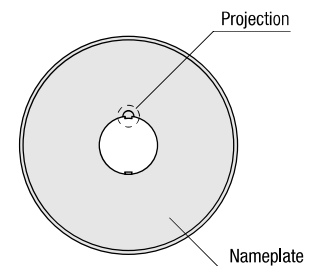

Handling



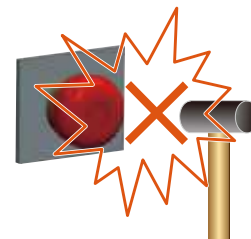

Do not expose the switch to excessive shock and vibration, otherwise the switch may be deformed or damaged, causing malfunction or operation failure.



ø16 X6/XA Series Emergency Stop Switches Accessories

Accessories and Replacement Parts (ø16 X6/XA Series Emergency Stop Switches)

Package quantity: 1

| Description & Shape | Material | Part No. | Ordering No. | Package Quantity | Remarks |
|--|--------------------------------|-------------|--------------|------------------|---|
|  | Metal (nickel-plated brass) | MT-001 | MT-001 | 1 | <ul style="list-style-type: none"> Used to tighten the locking ring when installing the XA emergency stop switch onto a panel. |
|  | Polyamide | XA9Z-LN | XA9Z-LNPN10 | 10 | <ul style="list-style-type: none"> Black |
|  | PBT | XA9Z-VL2 | XA9Z-VL2PN02 | 2 | <ul style="list-style-type: none"> White Used for solder terminals. Also applicable to the XW series. |
|  | For Solder Terminal | XA9Z-LED2R | XA9Z-LED2R | 1 | <ul style="list-style-type: none"> Replacement LED unit for illuminated (for XA series only). |
| | For PC Board Terminal | XA9Z-LED2VR | XA9Z-LED2VR | | |
|  | Stainless Steel | MT-101 | MT-101 | | <ul style="list-style-type: none"> Used for removing the LED unit. |

Nameplates (for ø16 X6/XA Emergency Stop Switches)

Package quantity: 1

| Description | Legend | Part No. | Material | Plate Color | Legend Color |
|--------------------|----------------|----------|-----------|-------------|--------------|
| For ø30mm Operator | (blank) | HAAV-0 | Polyamide | Yellow | Black |
| | EMERGENCY STOP | HAAV-27 | | | |
| For ø40mm Operator | (blank) | HAAV4-0 | | | |
| | EMERGENCY STOP | HAAV4-27 | | | |

• Cannot be used with a switchguard.

For ø30mm Operator

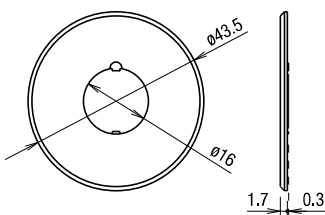

• Panel thickness when using the nameplate: 0.5 to 2 mm

For ø40mm Operator

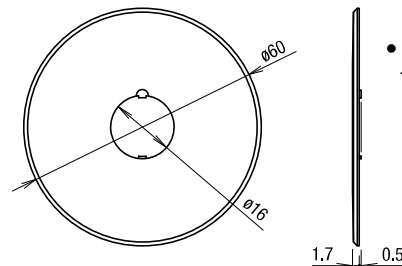

• Panel thickness when using the nameplate: 0.5 to 2 mm

All dimensions in mm.

For more information, visit <http://eu.idec.com>

Emergency Stop Guard for Machinery (Protective Shroud)

If the safety requirements of ISO15380:2015 4.3.2 or 4.5 is satisfied, the switchguard can be used safely by combining IDEC's switchguard and emergency stop switch, which is approved by TÜV Rheinland in ISO13850:2015 to be used as protective shroud with emergency stop switch.

In the past, use of a switchguard (term: protective shroud) on devices such as a machine tool or food processing machines was not permitted under ISO/IEC. However, in the latest revision, the use of a protective shroud is permitted with conditions. This is because the "Prevention of unintended actuation of an emergency stop device" was added as a safety requirement and the definition of a protective shroud is as below.

ISO13850:2015 3.7 protective shroud (protective shroud)
mechanical measure provided to reduce the possibility of unintended actuation of an emergency stop device.

Productive shroud can be used under the following conditions:

ISO13850:2015 4.5 Prevention of unintended acuation of an emergency stop device

The emergency stop device shall be designed to avoid unintended actuation.

The actuation of the emergency stop device shall not be impaired.

To prevent unintended actuation of the emergency stop device some precautions can be taken, e.g.:

- locate the emergency stop device away from foreseeable heavily trafficked areas,
- select the type of emergency stop device,
- select appropriate size or shape of the emergency stop device, or
- mount the emergency stop device within a recessed surface of the surrounding control panel.

The use of a protective shroud around the emergency stop device should be avoided, except when necessary to prevent unintended actuation and other measures are not practicable.

For emergency stop devices intended to be acutated by the hand the measures against unintended actuation shall not impede or hinder actuation with the palm of the hand, from any foreseeable position of the machine operator and others who could need to actuate them.

For details on protective shroud, see **D-055**.

APEM

Switches &
Pilot Lights

Control Boxes

Emergency
Stop SwitchesEnabling
Switches

Safety Products

Explosion Proof

Terminal Blocks

Relays & Sockets

Circuit
Protectors

Power Supplies

LED Illumination

Controllers

Operator
Interfaces

Sensors

AUTO-ID

X6

XA

XW

XN

SEMI

| | | | | Model | Mark | Page | | | | |
|--|---|--|--|--|---|--|--|-------------------------|--|-------|
| <p>New Concept Reverse Energy Structure Safe Break Action</p> <p>ø16mm Mount Hole</p> <p>Non illuminated</p> <p>Detachable Contact Block</p> <p>Pushlock Pull or Turn Reset</p> <p>ø29mm Button</p> <p>ø40mm Button</p> | <p>ø16mm Mount Hole</p> <p>Non illuminated</p> <p>Detachable Contact Block</p> <p>Pushlock Pull or Turn Reset</p> <p>ø29mm Button</p> <p>ø40mm Button</p> | <p>Unibody (no safe break action)</p> <p>Pushlock Pull or Turn Reset</p> <p>ø29mm Button</p> <p>ø40mm Button</p> | <p>Pushlock Pull or Turn Reset</p> <p>ø29mm Button</p> <p>ø40mm Button</p> | XA1E-BV3 (Solder, PC Board Terminal) | | D-018 | | | | |
| | | | | XA1E-BV4 (Solder, PC Board Terminal) | | D-018 | | | | |
| | | | | AB6E-3BV (Solder Terminal) | | D-010 | | | | |
| | | | | XA1E-BV3U (Solder, Solder/ Tab #110 Terminal) | | D-016 | | | | |
| | | | | AB6E-4BV (Solder Terminal) | | D-010 | | | | |
| | | | | XA1E-BV4U (Solder, Solder/ Tab #110 Terminal) | | D-016 | | | | |
| | | | | XA1E-LV3 (Solder, PC Board Terminal) | | D-018 | | | | |
| | | | | XA1E-LV4 (Solder, PC Board Terminal) | | D-018 | | | | |
| | | | | XW1E-BV4TG (Screw Terminal) | <p>Mechanical Indicator Model</p> | D-033 | | | | |
| | | | | XW1E-BV4 (Screw Terminal) | | D-027 | | | | |
| | | | | XW1E-BV4 (Solder, PC Board Terminal) | | D-027 | | | | |
| | | | | <p>New Concept Reverse Energy Structure Safe Break Action</p> <p>ø22mm Mount Hole</p> <p>Non illuminated</p> <p>Detachable Contact Block</p> <p>Pushlock Pull or Turn Reset</p> <p>ø40mm Button</p> <p>ø60mm Button</p> | <p>ø22mm Mount Hole</p> <p>Non illuminated</p> <p>Detachable Contact Block</p> <p>Pushlock Pull or Turn Reset</p> <p>ø40mm Button</p> <p>ø60mm Button</p> | <p>Pushlock Pull or Turn Reset</p> <p>ø40mm Button</p> <p>ø60mm Button</p> | <p>Pushlock Pull or Turn Reset</p> <p>ø40mm Button</p> <p>ø60mm Button</p> | XW1E-BV4 (Connector) | | D-027 |
| XW1E-BV5 (Screw Terminal) | | D-027 | | | | | | | | |
| XW1E-BV4TG (Screw Terminal) | <p>Mechanical Indicator Model</p> | D-033 | | | | | | | | |
| XW1E-LV4 (Screw Terminal) | | D-028 | | | | | | | | |
| XW1E-LV4 (Solder, PC Board Terminal) | | D-028 | | | | | | | | |
| <p>ø22mm Mount Hole</p> <p>Illuminated</p> <p>Detachable Contact Block</p> <p>Pushlock Pull or Turn Reset</p> <p>ø40mm Button</p> | <p>ø22mm Mount Hole</p> <p>Illuminated</p> <p>Detachable Contact Block</p> <p>Pushlock Pull or Turn Reset</p> <p>ø40mm Button</p> | <p>Pushlock Pull or Turn Reset</p> <p>ø40mm Button</p> | <p>Pushlock Pull or Turn Reset</p> <p>ø40mm Button</p> | | | | | | | |
| | | | | | | | | | | |

(Continued on Next Page)

(Continued from previous page)

| | | Model | Mark | Page | | | | | |
|--|--------------------------|-----------------------------|--------------------------|-----------------------------|--------------|--------------------------|--------------------------|-------------|--------------------------|
| Push-ON | Detachable Contact Block | Pushlock Pull or Turn Reset | ø40mm Button | XW1E-TV4 (Screw Terminal) | | D-028 | | | |
| | | | | XW1E-TV4 (Connector) | | D-028 | | | |
| New Concept Reverse Energy Structure Safe Break Action | ø30mm Mount Hole | Non illuminated | Detachable Contact Block | Pushlock Pull or Turn Reset | ø40mm Button | Plastic Bezel | XN1E-BV4 (Plastic Bezel) | | D-039 |
| | | | | | | | ø60mm Button | Flush Bezel | XN5E-BV4 (Flush Bezel) |
| Illuminated | Detachable Contact Block | Pushlock Pull or Turn Reset | ø40mm Button | Plastic Bezel | Flush Bezel | XN1E-BV5 (Plastic Bezel) | | | |
| | | | | | | Pushlock Turn Reset | ø44mm Button | Padlockable | XN4E-BL4 (Padlockable) |
| Push-ON | Detachable Contact Block | Pushlock Pull or Turn Reset | ø40mm Button | Plastic Bezel | Flush Bezel | | | | XN1E-LV4 (Plastic Bezel) |
| | | | | | | Pushlock Turn Reset | ø44mm Button | Padlockable | XN5E-LV4 (Flush Bezel) |
| Push-ON | Detachable Contact Block | Pushlock Pull or Turn Reset | ø40mm Button | Plastic Bezel | Flush Bezel | | | | XN1E-TV4 (Plastic Bezel) |
| | | | | | | Pushlock Turn Reset | ø44mm Button | Padlockable | XN5E-TV4 (Flush Bezel) |
| Accessories | Emergency Stop Nameplate | Pushlock Turn Reset | ø44mm Button | Padlockable | | | | | |
| | | | | | | ø16mm Mount Hole | HAAV | | |
| ø22mm Mount Hole | HWAV | D-049 | | | | | | | |
| ø30mm Mount Hole | HNAV | D-050 | | | | | | | |